

Answer Key

Great Authors

Across

5. Charles Dickens
8. Roald Dahl
9. Laura Ingalls Wilder

Down

1. William Shakespeare
2. Maurice Sendak
3. Mark Twain
4. J. K. Rowling
6. Edgar Allan Poe
7. Dr. Seuss

Connect the Dots: The Peacekeepers

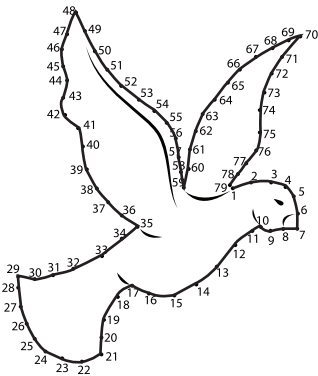

God Save the Queen!

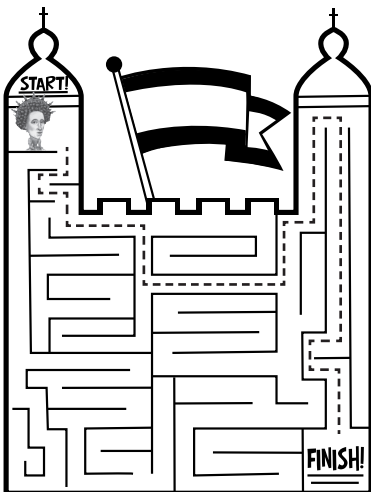

Match the Frontier Facts

- I was born near what is now Birdsboro, Pennsylvania. (Daniel Boone)
- I was born near what is now Limestone, Tennessee. (Davy Crockett)
- I was known for my coonskin cap. (Davy Crockett)
- I was held captive by the American Indians from the Shawnee tribe because I was hunting on their lands. (Daniel Boone)
- I was elected to Congress in 1827. (Davy Crockett)
- As a teenager, I killed my first bear when I should have been tending my family's cows. (Daniel Boone)
- I claimed to have killed 105 bears in one season. (Davy Crockett)
- I rescued my thirteen-year-old daughter, Jemima, when she was kidnapped by American Indians. (Daniel Boone)
- I led the first pioneers across the Appalachian Mountains. (Daniel Boone)
- I fought and died at the Alamo. (Davy Crockett)

The French Chef

H	S	I	N	R	A	G	A	R	M	E	H
A	A	V	F	O	G	G	R	R	E	F	A
D	U	Q	I	A	Z	O	O	L	B	W	B
B	T	Y	J	S	U	K	A	M	R	Q	R
S	E	W	D	X	J	V	S	A	Z	Y	O
E	K	I	I	M	P	I	T	Q	O	B	I
A	C	V	C	Y	E	N	G	R	I	L	L
R	X	Z	E	T	H	U	N	A	Y	T	M
S	A	H	G	P	A	R	E	B	J	W	G

The Great Escape!

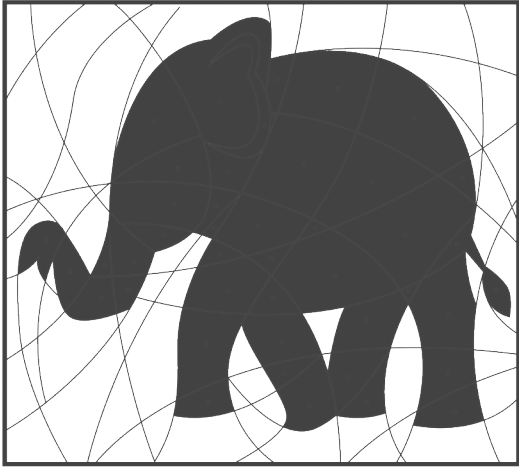

Battle of the Lees

- Studying philosophy in college taught me that being prepared is the best way to avoid a fight, not start one. (Bruce Lee)
- Robert Louis Stevenson's *The Strange Case of Dr. Jekyll and Mr. Hyde* inspired one of my most popular characters. (Stan Lee)
- I was so strong, I could do fifty chin-ups with only one arm. (Bruce Lee)
- I became a soldier because my family did not have enough money to send me to college. (Robert E. Lee)
- I created a shy, nerdy superhero who was unlike all the other giant, muscle-bound heroes in other comic books. (Stan Lee)
- I helped redraw maps to include land won by the United States during the Mexican-American War. (Robert E. Lee)
- My motto is "Excelsior!" (Stan Lee)
- I said I would rather "die a thousand deaths" than surrender. (Robert E. Lee)
- I was born in 1940, in the year and the hour of the dragon. (Bruce Lee)

- I was accused of committing treason. (Robert E. Lee)
- I changed the company name of Timely Comics to Marvel Comics. (Stan Lee)
- I once said, "If the enemy is cool, stay cooler than him. If the enemy moves, move faster than him." (Bruce Lee)

Two Truths and a Lie

- Lie: I wore false teeth made of wood.
- Lie: I was the second president of the United States.
- Lie: I won every battle I fought as commander of the Continental Army.

Famous Brain

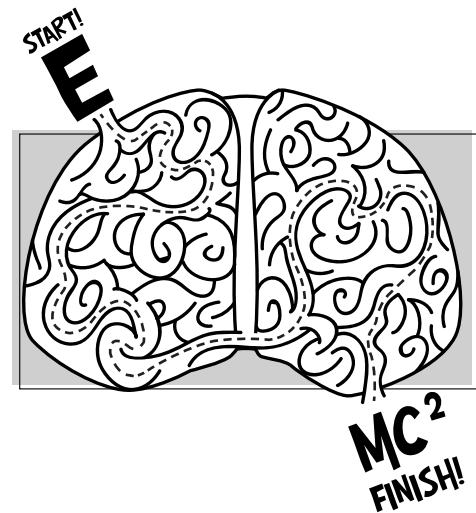

Apple Picking

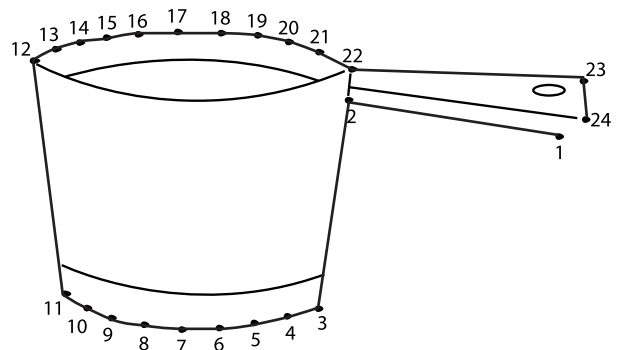

The Odditorium

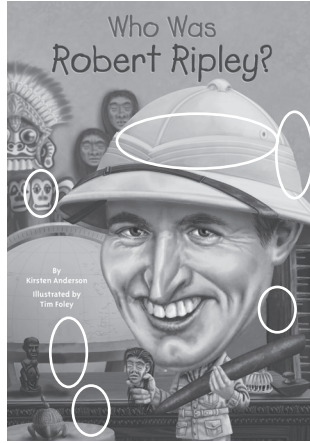
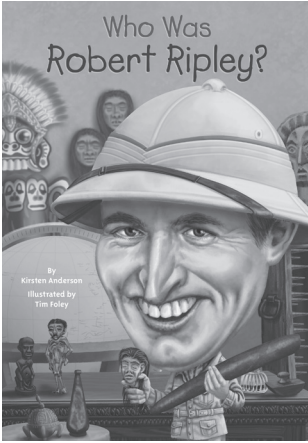

Also Known As

- Samuel Clemens—Mark Twain
- Cassius Clay Jr.—Muhammad Ali
- Erik Weisz—Harry Houdini
- Rolihlahla Mandela—Nelson Mandela
- Andrew Warhola—Andy Warhol
- Agnes Bojaxhiu—Mother Teresa
- John Chapman—Johnny Appleseed
- Theodor Geisel—Dr. Seuss
- Stanley Lieber—Stan Lee

Braille Decoder

He opened the doors of knowledge to all those who cannot see.

Scientists and Inventors

Across

5. Steve Jobs
6. Marie Curie
7. Bill Gates
8. Isaac Newton

Down

1. Alexander Graham Bell
2. Thomas Edison
3. Galileo
4. Benjamin Franklin

A Bright Idea!

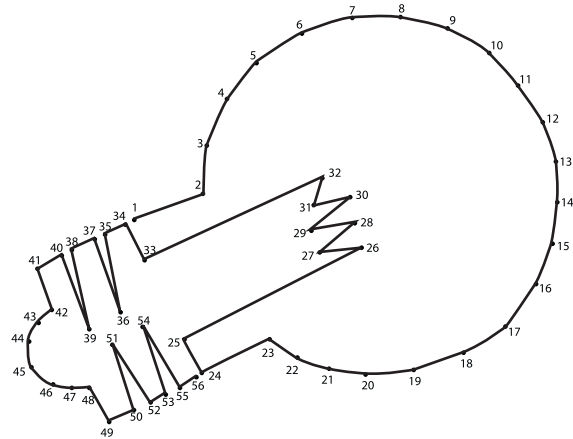

Girl Power!

G	I	D	O	C	S	A	X	R	M	K	E	Z	P	D	E
B	L	R	F	P	G	B	K	C	E	F	L	B	G	F	B
N	Q	U	I	A	Z	I	O	L	B	W	E	I	L	H	G
W	Y	T	J	S	U	G	A	M	R	Q	A	U	O	A	U
S	U	S	A	N	B	A	N	T	H	O	N	Y	R	L	F
P	K	I	I	M	H	I	X	Q	E	B	O	F	I	Q	X
A	M	A	B	O	E	L	L	E	H	C	I	M	A	W	O
N	I	Z	E	T	L	A	N	A	Y	T	M	V	S	I	S
J	A	H	G	E	A	D	E	B	J	W	G	B	T	Q	K
O	G	S	E	H	T	A	T	P	O	U	U	N	E	W	A
B	E	T	Y	A	K	M	O	U	T	H	Y	T	I	A	L
S	O	V	L	V	E	S	H	O	U	T	D	S	N	P	Z
E	L	E	A	N	O	R	R	O	O	S	E	V	E	L	T
L	W	I	U	R	F	Z	P	Y	T	E	J	R	M	A	Y

Beatlemania

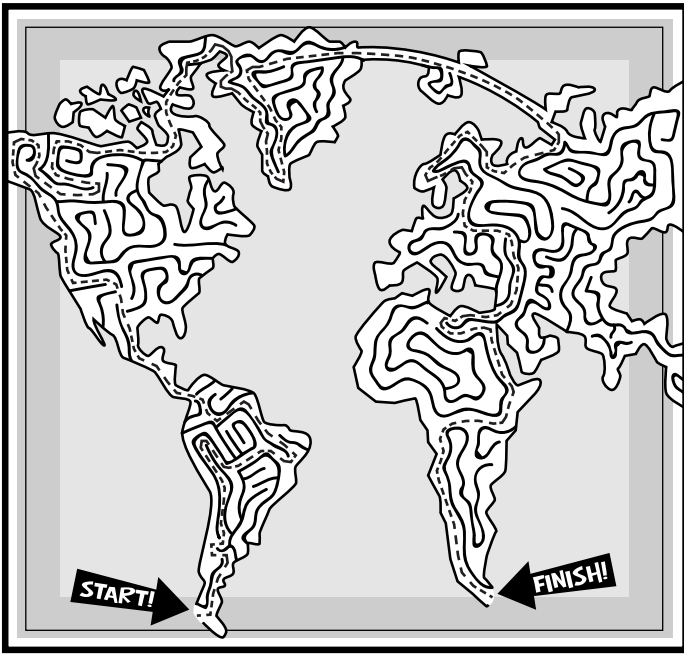

Mapping the World

Across

1. Christopher Columbus
7. Neil Armstrong

Down

2. Sacagawea
3. Ernest Shackleton
4. Amelia Earhart
5. Ferdinand Magellan
6. Marco Polo

Batter Up!

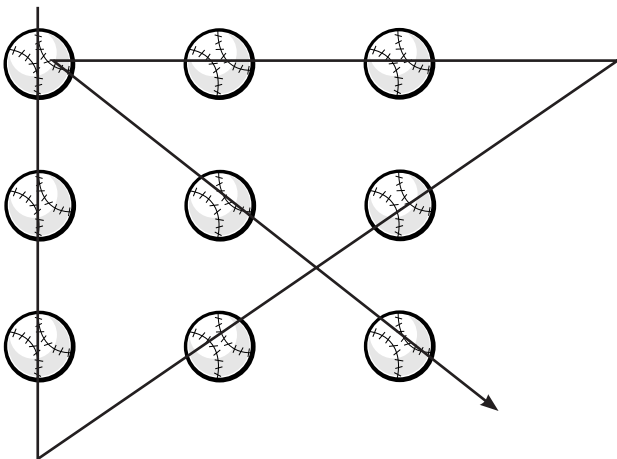

Great Artists

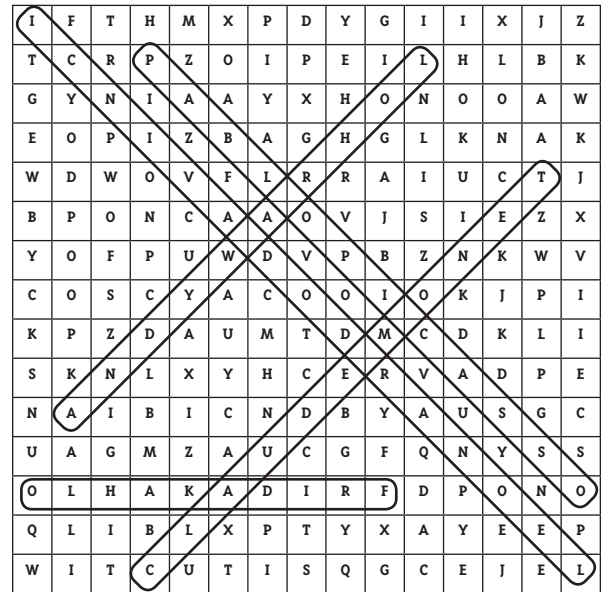

Bill and Steve's Excellent Adventure

- My parents adopted me in 1955. (Steve Jobs)
- I wrote my first computer program when I was thirteen years old. (Bill Gates)
- I loved to eat fruit, so I named my company after my favorite fruit of all, the apple! (Steve Jobs)
- I created the software known as Windows. (Bill Gates)
- A famous commercial for my company aired during the Super Bowl in 1984. (Steve Jobs)
- I got an honorary degree from Harvard University, after quitting more than thirty years earlier! (Bill Gates)
- I was a driving force in computer animation and convinced Disney to pay Pixar to make three full-length animated films. (Steve Jobs)
- I started teaching myself computer languages in seventh grade. (Bill Gates)
- I became a millionaire when I was twenty-five years old. (Steve Jobs)
- I became a self-made billionaire when I was thirty-one years old. (Bill Gates)

Stand Up for Your Rights

Across

- Rosa Parks
- Nelson Mandela
- Harriet Tubman

Down

- Harriet Beecher Stowe
- Frederick Douglass
- Gandhi
- Martin Luther King Jr.

Presidential Mix-Up!

EOERGG AONTWHGINS—George Washington

MBAARHA LOINCLN—Abraham Lincoln

HONJ F. DNENKEY—John F. Kennedy

RANOLD GAERAN—Ronald Reagan

KARACB MAABO—Barack Obama

SATHMO FEFJERSNO—Thomas Jefferson

ROODEHTE VTROSOEEL—Theodore Roosevelt

KRAINNFL RTVOSOELE—Franklin Roosevelt

ODOROWW SILNOW—Woodrow Wilson

Fly Away!

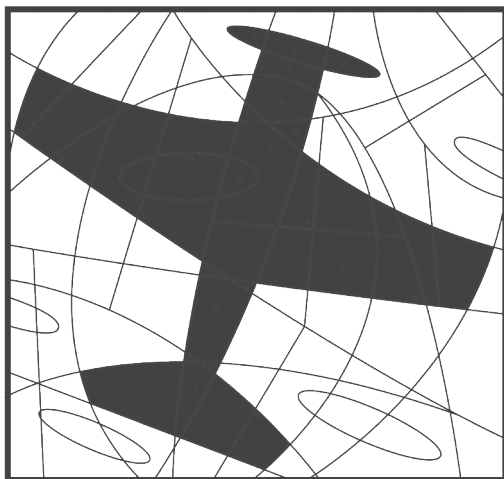

Space: The Final Frontier

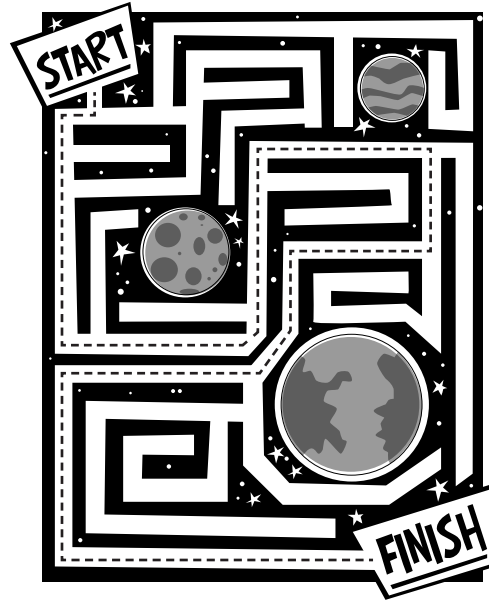

Musical Superstars

H	E	D	O	C	S	A	X	R	M	K	E	Z	P	D	E	T	A	C	Q	U
V	L	O	F	P	G	B	K	C	E	F	L	B	G	F	B	H	B	A	Z	R
N	Q	L	B	A	Z	I	O	L	B	W	E	I	B	H	G	E	O	U	I	Q
W	Y	L	O	U	I	S	A	R	M	S	T	R	O	N	G	B	J	N	B	Y
S	U	Y	J	N	B	A	N	T	H	O	N	Y	B	L	F	E	B	M	H	U
P	K	P	B	M	H	I	X	Q	E	B	O	F	D	Q	X	A	Y	O	E	K
A	M	A	Y	O	E	L	L	E	H	C	I	M	Y	W	O	T	I	T	L	M
N	I	R	I	T	L	A	N	A	Y	T	M	V	L	I	S	L	A	E	A	I
J	A	T	A	E	A	D	E	B	J	W	G	B	A	Q	K	E	N	H	T	A
O	G	O	N	H	T	A	T	P	O	U	U	N	N	W	A	S	Y	E	L	G
B	E	N	Y	E	L	V	I	S	P	R	E	S	L	E	Y	T	O	L	B	E
S	O	B	L	V	E	S	H	O	U	T	D	S	N	P	Z	R	A	R	M	O
E	L	U	A	N	O	R	R	O	O	S	E	V	E	L	T	P	N	T	H	L
W	O	L	F	G	A	N	G	A	M	A	D	E	U	S	M	O	Z	A	R	T

On the Battlefield

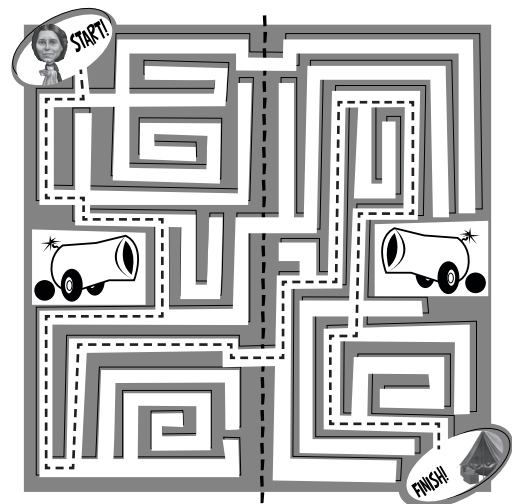

Curse of the Mummy

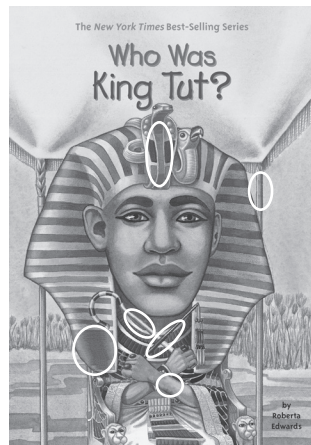
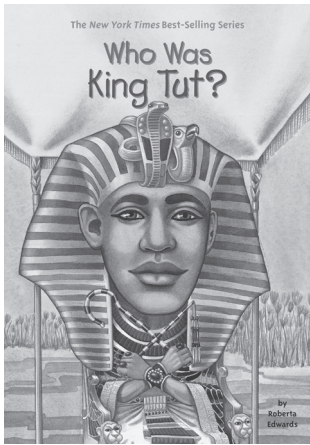

The Original Girl Guide



Follow the Underground Railroad

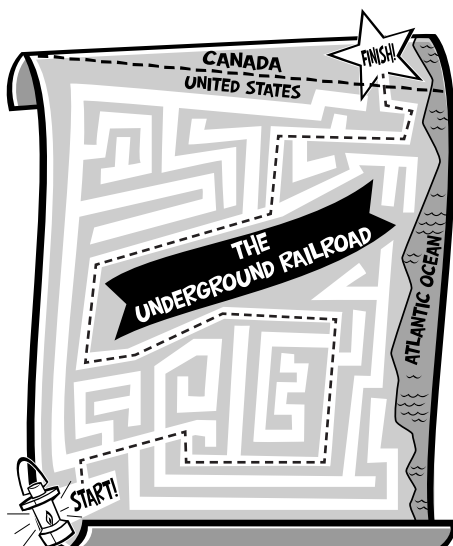

Animal Lovers

- I grew up on my parents' wildlife park in Australia. (Steve Irwin)
- When I was ten years old, I took a voyage across the Atlantic and fell in love with ships! (Jacques Cousteau)
- I grew up in England and from a young age, I was fascinated by animal behavior. (Jane Goodall)
- I helped my father trap crocodiles when I was a child. (Steve Irwin)
- I was a pioneer of new techniques for diving, breathing, and filming underwater. (Jacques Cousteau)
- When I was twenty-six, I visited Africa and studied chimpanzees in their natural habitat. (Jane Goodall)
- I made scuba diving a popular, adventurous pastime in the 1950s. (Jacques Cousteau)
- I died when I was attacked by a stingray while filming a documentary. (Steve Irwin)
- I founded an institute in 1977 to bring awareness and understanding about the treatment of chimpanzees around the world. (Jane Goodall)

Count the Apples

69